

## TULSA PLANT

ADDRESS: 10733 E. Ute, Tulsa, OK 74116  
 PHONE: 918-836-3535 FAX: 918-832-9978  
 TOLL FREE: 800-532-9747

## DALLAS PLANT

ADDRESS: 1130 Quaker St., Dallas, TX 75207  
 PHONE: 214-637-5900 FAX: 214-951-0469  
 TOLL FREE: 800-569-5683

### TINT SAMPLES

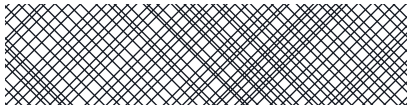

CROSSHAIR

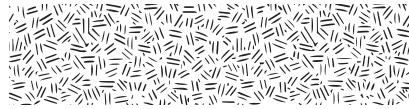

CONFETTI



FDIC

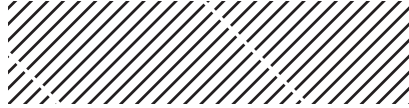

LAID

### TITHE ENVELOPE

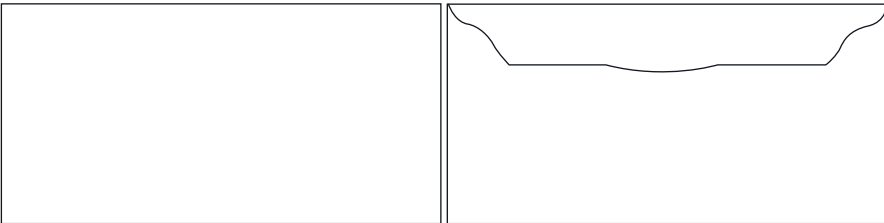

3 1/8" x 6 1/4" TAB

Standard Square Corner Window Positions and Size

#10 Commercial Window Material Available

Polystyrene and Glassine

Special Window Sizes and Positions Available

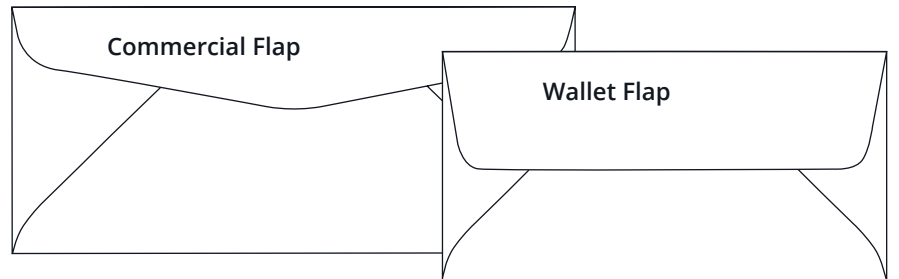
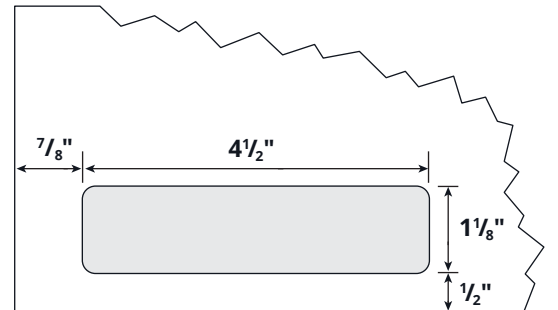

### BOOKLET ENVELOPES

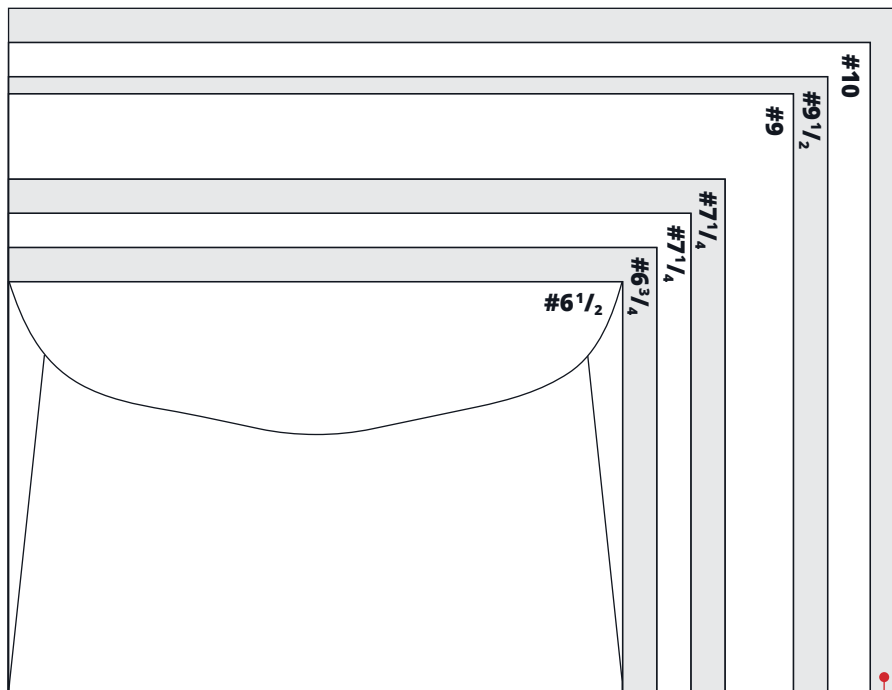

- #6 1/2 (6" x 9")
- #6 3/4 (6 1/2" x 9 1/2")
- #7 1/4 (7" x 10")
- #7 1/2 (7 1/2" x 10 1/2")
- #9 (8 3/4" x 11 1/2")
- #9 1/2 (9" x 12")
- #10 (9 1/2" x 12 5/8")
- #13 (10" x 13")

### COMMERCIAL ENVELOPES

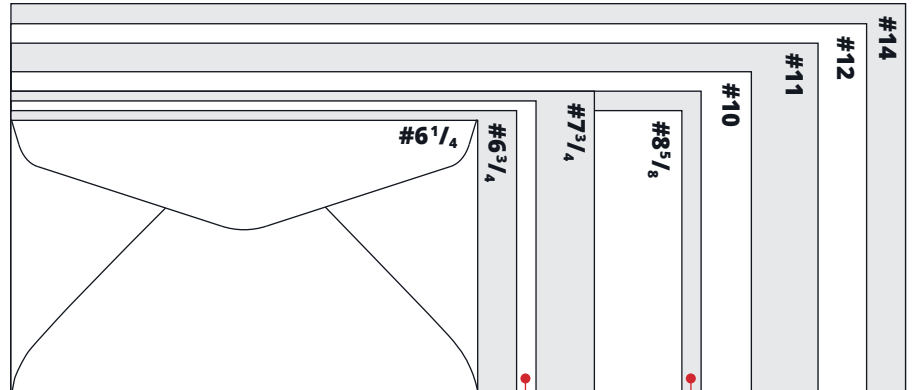

- #6 1/4 (3 1/2" x 6")
- #6 3/4 (3 5/8" x 6 1/2")
- #7 (3 3/4" x 6 3/4")
- #7 1/4 (3 7/8" x 7 1/2") and Monarch
- #8 5/8 (3 5/8" x 8 5/8")
- #9 (3 7/8" x 8 7/8")
- #10 (4 1/8" x 9 1/2")
- #11 (4 1/2" x 10 3/8")
- #12 (4 3/4" x 11")
- #14 (5" x 11 1/2")

### OPEN END ENVELOPES

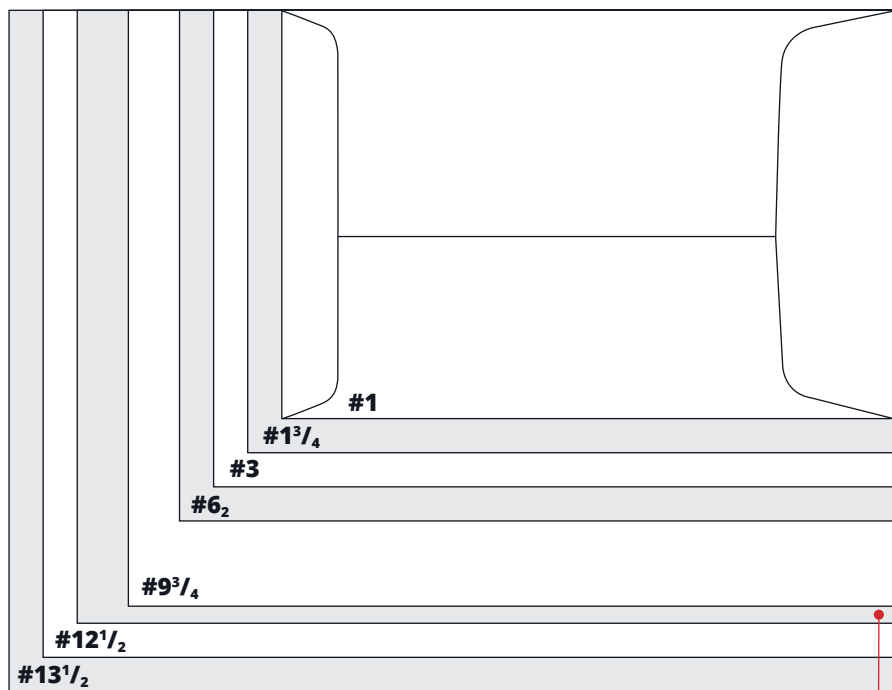

- #1 CATALOG (6" x 9")
- #1 3/4 CATALOG (6 1/2" x 9 1/2")
- #3 CATALOG (7" x 10")
- #6 CATALOG (7 1/2" x 10 1/2")
- #9 3/4 CATALOG (8 3/8" x 11 1/4")
- #10 1/2 CATALOG (9" x 12")
- #12 1/2 CATALOG (9 1/2" x 12 1/2")
- #13 1/2 CATALOG (10" x 13")

### REMIT ENVELOPE

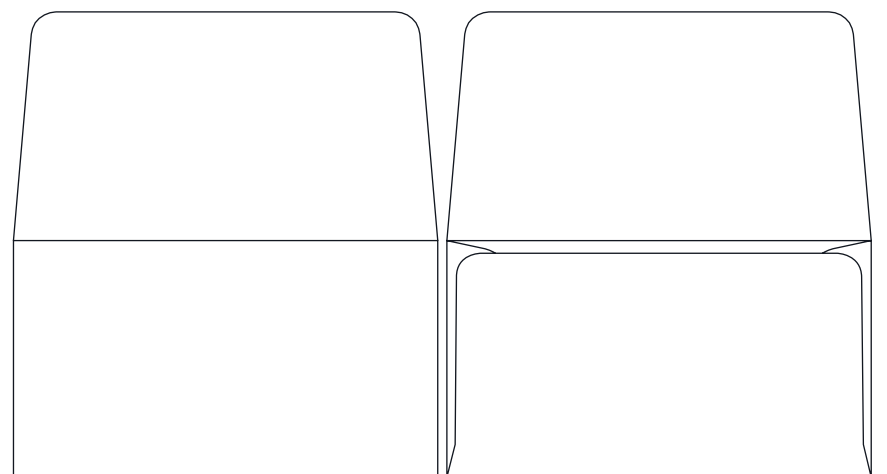

3 5/8" x 6 1/2"

### DRIVE-INS

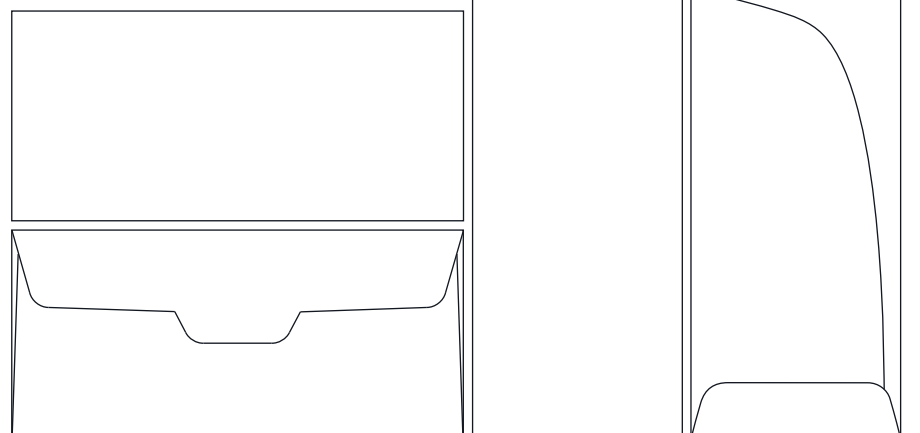

3 1/4" x 7" TAB  
 3 3/8" x 7 1/8" TAB

3 1/4" x 7" OE DI  
 3 3/4" x 7" OE DI